

PCB LAYOUT - COMPONENT VIEW

61203921621: pin 20 removed

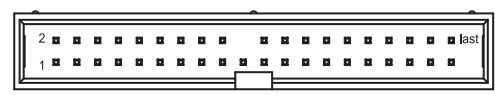

TECHNICAL CHARACTERISTICS

**MATERIAL**  
 INSULATOR: PBT  
 COLOR: BLACK  
 CONTACT MATERIAL: COPPER ALLOY  
 CONTACT TYPE: STAMPED  
 CONTACT PLATING: GOLD  
 QUALITY CLASS: 3 AS PER CECC 75 301-802  
 PITCH: 2.54MM

**ENVIRONMENTAL**  
 OPERATING TEMPERATURE: -40 UP TO 125°C  
 FLAMABILITY RATING: UL94-V0  
 COMPLIANCE: LEAD FREE AND ROHS

**ELECTRICAL**  
 CURRENT RATING: 3A MAX  
 WORKING VOLTAGE: 250V AC  
 INSULATOR RESISTANCE: >1000 MOHM  
 DIELECTRIC WITHSTANDING VOLTAGE: 500V AC/MN  
 CONTACT RESISTANCE: 20 mOHM MAX

**STANDARD**  
 CERTIFIED: E323964 / MODEL NUMBER 612-216

**SOLDERING**  
 WAVE PROCESS ONLY

**PACKAGING**  
 TRAY

**DIMENSION**  
 A = 2.54 x (NB. PIN / 2 - 1)  
 B = 2.54 x (NB. PIN / 2) + 7.66

NOTES:  
 No. Of Positions 50-64 With 3 Keys  
 All Oher Pin With 1 Key

RoHS Compliant				PROJECTION: 	GENERAL TOLERANCE .X = +/- 0.2 .XX = +/- 0.15		DESCRIPTION: 2.54MM MALE BOX HEADER  WERI PART NO: 612 0xx 216 21	SIZE <b>A4</b>				
G	30-JUL-10	39PIN DRAWING	JC						APPROVAL: RJ	UNIT: MM	DESCRIPTION: 2.54MM MALE BOX HEADER  WERI PART NO: 612 0xx 216 21	SIZE <b>A4</b>
F	13-JUL-10	PACKAGING	JC							SCALE:		
E	16-NOV-09	STANDARD	JP							SHEET: 1/2		
D	27-NOV-07	MODIFICATIONS	EC							DRAW: PEARL		
C	19-DEC-06	DRAW	EC									
B	21-JUN-04	LEAD FREE	JP									
A	09-MAR-99	PDF	JP									
REV	DATE	FILE	BY									

1

2

3

4

5

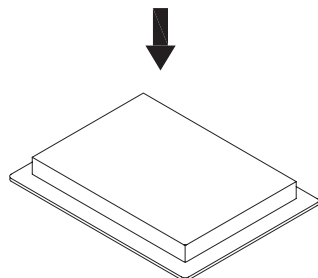
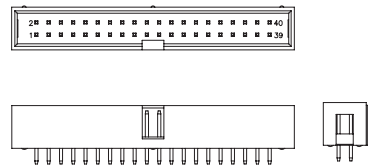

TRAY

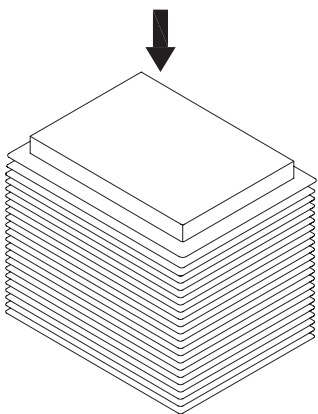

25TRAYS

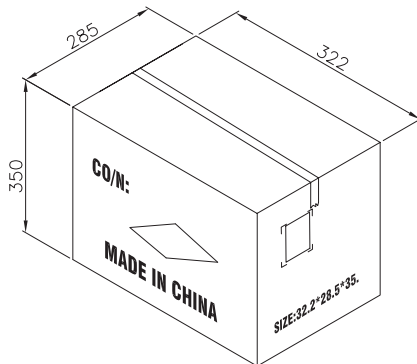
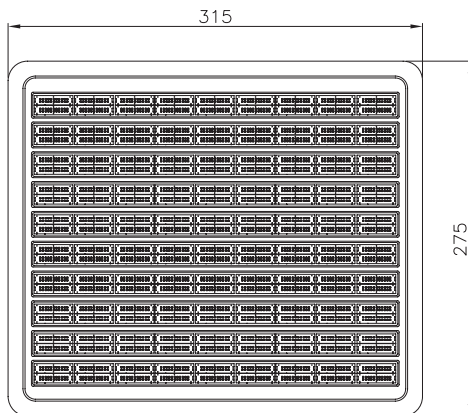

CARTON

Note:

1.Dimension:

Tray Size:315(L)x275(W)x15.4(H) (mm)

Carton Size:322(L)x285(W)x350(H) (mm)

2.Quantity:

Circuits	Pcs/Tray	Trays/Carton	Q'TY
06	360	25	9000
08	300	25	7500
10	260	25	6500
12	240	25	6000
14	200	25	5000
16	180	25	4500
20	160	25	4000
24	140	25	3500
26	120	25	3000
30	120	25	3000
34	100	25	2500
40	80	25	2000
50	60	25	1500
60	60	25	1500
64	60	25	1500

A

B

C

RoHS Compliant			
G			
F			
E			
D			
C			
B			
A			
REV	DATE	FILE	BY

PROJECTION:

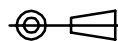

APPROVAL: RJ

GENERAL TOLERANCE

.X = +/- 0.2

.XX = +/- 0.15

UNIT: MM

SCALE:

SHEET: 2/2

DRAW: PEARL



DESCRIPTION: 2.54MM MALE BOX HEADER

WERI PART NO: 612 0xx 216 21

SIZE

A4

D